

www.paxtonagri.com

Agricultural

PRODUCT GUIDE

Paxton

Market leading manufacturer, supplying quality,
robust and award winning products to farmers
and smallholders for over 40 years



www.paxtonagri.com

Made in Britain



Key

Look out for these pictures to indicate which products are suitable for which animal.

They are on the top left of every product page and relate to all the products on that page unless specifically stated in the text.



Beef cattle

For our largest and most robust products



Horses & Ponies

Products that work well in the equine world



Dairy cattle

Will find most of the PAXTON range suitable



Sheep & Goats

Products for smaller livestock

Contents

Drinking troughs

Circular	3 - 5
Rectangular	6 - 11
Wall & Floor Mounted	11 - 14

Footbaths

Footbaths	15 - 16
Equestrian Water Trays	17
Hoof Spreading Footbaths	17 - 18

Sheep Dips

Sheep Dips	19 - 20
------------	---------

Feed Troughs

Hanging	21-22
Floor Standing	22 - 25

Water Tanks

Above & Below Ground Tanks	26 - 30
Slim line Tanks	30

Dairy Hygiene

Rectangular Wash Troughs	31 - 32
Trough Style Wash Troughs	32 - 33
Churns	34

Appendix

FAQs	1
Delivery Times	1
Materials / Quality	2
Installation & user guides	34
Colours	34

Made in Britain



www.paxtonagri.com

FAQS



Are PAXTON Agricultural products recyclable?

All our products are made from Polyethylene (PE) which is 100% recyclable.



What proportion of the products are recycled materials?

Various ratios of recycled polymer are used in our products dependent on colour, customer requirements and the intended application. When requested at the point of order we can usually guarantee a recycled content of 100% on black products.



Are Paxton products suitable for pigs?

In most cases Paxton products are fine for use by pigs, however, we do not guarantee them against being chewed.



What is the Byelaw 30 Kit?

The Byelaw 30 Kit is used in order to comply with the Byelaw 30 Regulation and is specifically used when connecting a tank to a mains water supply. The Byelaw 30 kit maintains the quality of the water in the tank.

The kit prevents water contamination with an insect proof screened vent and prevents back-flow of stored water into the mains (potable) supply.

Orders and delivery

All fully completed orders are processed within 24hrs. The majority of products are made to order. Please allow 2-3 weeks for delivery.

Durability

Moulded polyethylene (PE) is extremely durable with outstanding impact, fracture and shatter resistance properties. These mechanical properties are tested to BS 2782.

Manufacturing Standard

(As applicable) All Paxton products are manufactured to BS EN ISO 9001:2015.

Plastic materials: Mechanical properties tested to BS 2782.

Hot dipped galvanised: BS 729

Powder coating: BS 3900

Zinc coating: BS 1706

Weather Stability

PE is ideal for external applications. Materials used are UV stabilised to meet the demands of Northern Hemisphere weather conditions.

Maintenance Free

The solid body colour is permanently moulded-in, eliminating the need for maintenance painting. Units are wear resistant; scratches and parking nudges are less evident.

Recycling

Polyethylene (PE) is an environmentally friendly material and is 100% recyclable. Paxton products can be manufactured using recycled materials where appropriate.

Cleaning

Products should be flushed with clean water and then washed with a mild detergent solution using a bristle brush or sponge. Care should be taken not to apply undue pressure that may damage labels. Flush clean with water after washing.

Chemical Resistance

The material is resistant to most acids, salts and solvents. Environmental elements such as acid rain, soot, diesel fumes, salt and seawater will not corrode PE. Please visit our website for full details.



Drinking troughs



www.paxtonagri.com



909L Drinking troughs

909 litres



AT6 circular drinking trough

Large capacity trough
Smooth line interior for ease of cleaning
Single drainage outlet (outlet 1)
Integral Service box and removable lid (ref AT cover)
Part 2 compliant 1/2" ballcock
Manufactured from UV stabilised and frost resistant to -40 °C MDPE

	Dimensions Dia. mm	Drinking Height	Capacity Litres	Drainage Outlet	Ballcock & Fitting	Service Box Cover
AT6	1560 x 855H	785 mm	909	1 1/2"	Yes	Removable



2046L Drinking troughs



682L Drinking troughs

2046 litres



AT1 circular drinking trough

Large capacity trough for large herds in open areas
Smooth line interior for ease of cleaning
Low drinking height so animals can comfortably reach the water
Single drainage outlet (outlet 1)
Integral Service box and removable lid (ref AT cover)
Part 2 compliant 3/4" ballcock
Manufactured from UV stabilised and frost resistant to -40 °C MDPE

	Dimensions Dia. mm	Drinking Height	Capacity Litres	Drainage Outlet	Ballcock & Fitting	Service Box Cover
AT1	2210 x 806H	720 mm	2046	1 1/2"	Yes	Removable

682 litres



AT15 circular drinking troughs

Low drinking height so animals can comfortably easily reach the water
Smooth line interior for ease of cleaning
Single drainage outlet (outlet 1)
Integral Service box and removable lid (ref AT cover)
Part 2 compliant 1/2" ballcock
Manufactured from UV stabilised and frost resistant to -40 °C MDPE

	Dimensions Dia. mm	Drinking Height	Capacity Litres	Drainage Outlet	Ballcock & Fitting	Service Box Cover
AT15	1450 x 670H	619 mm	682	1 1/2"	Yes	Removable



1075L Drinking troughs



75L Drinking troughs

1075 litres



AT5 circular drinking troughs

Recommended for areas where a constant water supply is not available
Supplied without a filling mechanism
Smooth line interiors for ease of cleaning
Low drinking height so Cattle can comfortably reach the water
Single drainage outlet (outlet 1)
Manufactured from UV stabilised and frost resistant to -40 °C MDPE

	Dimensions Dia. mm	Drinking Height	Capacity Litres	Drainage Outlet	Ballcock & Fitting	Service Box Cover
AT5	1650 x 620H	620 mm	1075	1/2"	No	N/A

75 litres



WT75 R rectangular drinking troughs

Movable ballcock support allows choice of centre fill or end fill set up
Easy to clean, tough, double skin design
Drainage outlet (50mm) and plug included as standard
Part 2 compliant 1/2" ballcock
Bolt down points included as standard
Manufactured from UV stabilised and frost resistant to -40 °C MDPE
UV stabilised

	Dimensions mm	Drinking Height	Capacity Litres	Drainage Outlet	Ballcock & Fitting	Service Box Cover
WT75R	1190L x 430W x 340.5H	235 mm	75	50 mm	Yes	Removable



675L Drinking troughs



120L Drinking troughs

675 litres

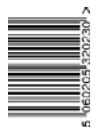

AT8 circular drinking troughs

Recommended for areas where a constant water supply is not available
Supplied without a filling mechanism
Smooth line interiors for ease of cleaning
Low drinking height so Beef Cattle can comfortably reach the water
Single drainage outlet (outlet 1)
Manufactured from UV stabilised and frost resistant to -40 °C MDPE

	Dimensions Dia. mm	Drinking Height	Capacity Litres	Drainage Outlet	Ballcock & Fitting	Service Box Cover
AT8	1330 x 620H	620 mm	675	1/2"	No	N/A

120 litres



WT120 R rectangular drinking troughs

Movable ballcock support allows choice of centre fill or end fill set up
Easy to clean, tough, double skin design
Drainage outlet (50mm) and plug included as standard
Part 2 compliant 1/2" ballcock
Bolt down points included as standard
Manufactured from UV stabilised and frost resistant to -40 °C MDPE
UV stabilised

	Dimensions mm	Drinking Height	Capacity Litres	Drainage Outlet	Ballcock & Fitting	Service Box Cover
WT120R	1190L x 430W x 456H	355 mm	120	50 mm	Yes	Removable



1136L Drinking troughs



1136 litres



AT22 rectangular drinking troughs

Free standing centre fill trough suitable for dairy cows and beef cattle
Ribbed walls for strength
Two drainage outlets (outlet 1)
Integral Service box and removable lid (ref ATL2 cover)
Part 2 compliant 1/2" ballcock
Manufactured from UV stabilised and frost resistant to -40 °C MDPE

	Dimensions mm	Drinking Height	Capacity Litres	Drainage Outlet	Ballcock & Fitting	Service Box Cover
AT22	2000L x 1200W x 795H	695 mm	1136	1 1/2" x 2	Yes	Removable



272L Drinking troughs



272 litres

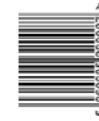

AT21 rectangular drinking troughs

Centre fill trough which will fit between two fields, yards or pens
272 litre capacity
Integral Service box and removable lid (ref ATL2 cover)
Part 2 compliant 1/2" ballcock
Manufactured from UV stabilised and frost resistant to -40 °C MDPE

	Dimensions mm	Drinking Height	Capacity Litres	Drainage Outlet	Ballcock & Fitting	Service Box Cover
AT21	1270L x 650W x 605H	510 mm	272	No	Yes	Removable



545L Drinking troughs



545 litres

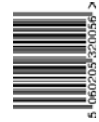

AT19 rectangular drinking troughs

Longer format centre fill trough
Includes two drainage outlets as standard (outlet 1)
Suitable for use indoors or in fields
Integral Service box and removable lid (ref ATL2 cover)
Part 2 compliant 1/2" ballcock
Manufactured from UV stabilised and frost resistant to -40 °C MDPE

	Dimensions mm	Drinking Height	Capacity Litres	Drainage Outlet	Ballcock & Fitting	Service Box Cover
AT19	2600L x 610W x 534H	460 mm	545	1 1/2" x 2	Yes	Removable



410L Drinking troughs



410 litres

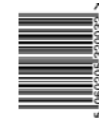

AT18 rectangular drinking troughs

Centre fill trough which will fit between two fields, yards or pens
410 litre capacity
Integral Service box and removable lid (ref ATL2 cover)
Part 2 compliant 1/2" ballcock
Manufactured from UV stabilised and frost resistant to -40 °C MDPE

	Dimensions mm	Drinking Height	Capacity Litres	Drainage Outlet	Ballcock & Fitting	Service Box Cover
AT18	1520L x 720W x 635H	535 mm	410	No	Yes	Removable



318L Drinking troughs



227L Drinking troughs

318 litres



AT2 rectangular drinking troughs

Popular end fill model
External rim and moulded in ribs for extra strength and stability
Single drainage outlet (outlet 1)
Integral Service box and removable lid (ref AT Cover)
Part 2 compliant 1/2" ballcock
Manufactured from UV stabilised and frost resistant to -40 °C MDPE

	Dimensions mm	Drinking Height	Capacity Litres	Drainage Outlet	Ballcock & Fitting	Service Box Cover
AT2	2019L x 559W x 559H	455 mm	318	1/2"	Yes	Removable

227 litres



AT24 rectangular drinking troughs

End fill design
One piece construction and smooth 'easy clean' surface
Single drainage outlet (outlet 1)
Integral Service box and removable lid (ref ATL2 cover)
Part 2 compliant 1/2" ballcock
Manufactured from UV stabilised and frost resistant to -40 °C MDPE

	Dimensions mm	Drinking Height	Capacity Litres	Drainage Outlet	Ballcock & Fitting	Service Box Cover
AT24	1400L x 560W x 500H	400 mm	227	1/2"	Yes	Removable



182L Drinking troughs



114L Drinking troughs

182 litres



AT3 rectangular drinking troughs

Popular end fill model
External rim and moulded in ribs for extra strength and stability
Single drainage outlet (outlet 1)
Integral Service box and removable lid (ref AT Cover)
Part 2 compliant 1/2" ballcock
Manufactured from UV stabilised and frost resistant to -40 °C MDPE

	Dimensions mm	Drinking Height	Capacity Litres	Drainage Outlet	Ballcock & Fitting	Service Box Cover
AT3	1353L x 559W x 535H	455 mm	182	1/2"	Yes	Removable

114 litres



AT16 rectangular drinking troughs

Centre fill design
One piece construction and smooth 'easy clean' surface
Integral Service box and removable lid (ref ATL2 cover)
Part 2 compliant 1/2" ballcock
Manufactured from UV stabilised and frost resistant to -40 °C MDPE

	Dimensions mm	Drinking Height	Capacity Litres	Drainage Outlet	Ballcock & Fitting	Service Box Cover
AT16	1000L x 430W x 455H	380 mm	114	No	Yes	Removable



77L Drinking troughs



17L Drinking bowls

77 litres



AT17 rectangular drinking troughs

Centre fill design
One piece construction and smooth 'easy clean' surface
Integral Service box and removable lid (ref ATL2 cover)
Part 2 compliant 1/2" ballcock
Manufactured from UV stabilised and frost resistant to -40 °C MDPE

	Dimensions Dia. mm	Drinking Height	Capacity Litres	Drainage Outlet	Ballcock & Fitting	Service Box Cover
AT17	1000L x 430W x 355H	280 mm	77	No	Yes	Removable

17 litres



AT23 round end drinking bowls

Corner bowl
Wall mounted
Built in mounts for easy wall fixing
Includes removable service box cover for easy access to ballcock
Includes Part 2 ballcock compliant with Water Regulations
Large easy drain screw cap for fast emptying

	Dimensions mm	Drinking Height	Capacity Litres	Drainage Outlet	Ballcock & Fitting	Service Box Cover
AT23	580D x 430W x 270H	Wall mounted	17	46mm	Yes	Removable



6.8L Drinking bowls



27L Drinking bowls

6.8 litres



AT25 drinking bowls

Compact design with built in mounts for easy wall fixing
Ideal for single animal use in loose boxes or stables
Large easy drain screw cap for fast emptying
Includes removable service box cover for easy access to ballcock
Left and right Ballcock fixing
Includes Part 2 ballcock compliant with Water Regulations

	Dimensions mm	Drinking Height	Capacity Litres	Drainage Outlet	Ballcock & Fitting	Service Box Cover
AT25	410D x 300W x 344H	Wall Mounted	6.8	46mm	Yes	Removable

27 litres



AT11 round end drinking bowls

Large capacity bowl
Ideal for single animal use in loose boxes or stables
19 mm outlet with 25 mm grommet for drainage
Includes removable service box cover for easy access to ballcock
Includes Part 2 ballcock compliant with Water Regulations

	Dimensions mm	Drinking Height	Capacity Litres	Drainage Outlet	Ballcock & Fitting	Service Box Cover
AT11	552D x 457W x 254H	Floor Mounted	27	19 mm	Yes	Removable



45L Drinking bowls



10L Drinking bowls

45 litres

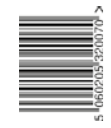

AT20 round end drinking bowls

- Floor standing trough
- Ideal for single animal use in loose boxes or stables
- Includes removable service box cover for easy access to ballcock
- Includes Part 2 ballcock compliant with Water Regulations

	Dimensions mm	Drinking Height	Capacity Litres	Drainage Outlet	Ballcock & Fitting	Service Box Cover
AT20	700D x 550W x 410H	235 mm	45	No	Yes	Removable

10 litres



WT10 rectangular drinking bowls

- Easy to clean, strong, double skin construction
- 80mm drainage outlet to increase drainage speed
- 3 strong double skin easy fixing location points
- Angled lower body section to allow full drainage
- Supplied with standard ballcock
- Visible grey drainage cap for easy location
- Manufactured from frost resistant, UV stabilised MDPE

	Dimensions mm	Drinking Height	Capacity Litres	Drainage Outlet	Ballcock & Fitting	Service Box Cover
WT10	383D x 320W x 288H	Wall mounted	10	80 mm	Yes	Removable



19L Drinking bowls



7.5L Drinking bowls

19 litres



WT19 rectangular drinking bowls

- Easy to clean, strong, double skin construction
- 70 mm drainage bung for rapid emptying in under 38 seconds
- 4 integral robust wall fixing points
- Left and right ballcock fixing
- Part 2 compliant 1/2" ballcock
- Large removable service box cover for easy access to the ballcock
- Manufactured from frost resistant, UV stabilised MDPE

	Dimensions mm	Drinking Height	Capacity Litres	Drainage Outlet	Ballcock & Fitting	Service Box Cover
WT19	403D x 500W x 308H	Wall mounted	19	70 mm	Yes	Removable

7.5 litres



WT7 round end drinking bowls

- Easy to clean, strong, double skin construction
- 80 mm drainage bung for rapid emptying in under 38 seconds
- 4 integral robust wall fixing points
- Left and right ballcock fixing
- Includes Part 2 ballcock compliant with Water Regulations
- Can be filled from mains & does not need a header tank to be WRAS compliant
- Large removable service box cover for easy access to the ballcock
- Manufactured from frost resistant, UV stabilised MDPE

	Dimensions mm	Drinking Height	Capacity Litres	Drainage Outlet	Ballcock & Fitting	Service Box Cover
WT7	373D x 308W x 320H	Wall mounted	7.5	80 mm	Yes	Removable

Footbaths



www.paxtonagri.com



180L

Footbaths



180 litres



FB1 walk through footbath

Anti-slip base for safe, quick penetration of footrot treatments
Safe, large radius corners with smooth edges
Resistant to all footrot chemicals
Easy to clean and handle
Tough one piece moulds

	Dimensions mm	Capacity Litres
FB1	2000L x 850W x 150H	180



86L

Footbaths



309L

Footbaths



86 litres

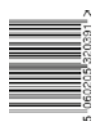

FB2 walk through footbath

Traditional style footbath commonly used with formalin
Ribbed base for safe, quick penetration of footrot treatments
Resistant to all footrot chemicals
Easy to clean and handle
Tough one piece moulds
Can be linked together length wise for longer runs

	Dimensions mm	Capacity Litres
FB2	3000L x 470W x 180H	86

309 litres



FB4 walk through footbath

Anti-slip base for safe, quick penetration of footrot treatments
Safe, large radius corners with smooth edges
Resistant to all footrot chemicals
Easy to clean and handle
Tough one piece moulds

	Dimensions mm	Capacity Litres
FB4	3050L x 915W x 150H	309



700L

Footbaths



75L

Footbaths

700 litres



FB5/WT3 footbath/equestrian tray

Anti-slip base for safe, quick penetration of footrot treatments
Safe, large radius corners with smooth edges
Resistant to all footrot chemicals
Easy to clean and handle
Tough one piece moulds
FB5 can also be used as a water tray (WT3)

	Dimensions mm	Capacity Litres
FB5/WT3	3150L x 1635W x 166H	700

75 litres

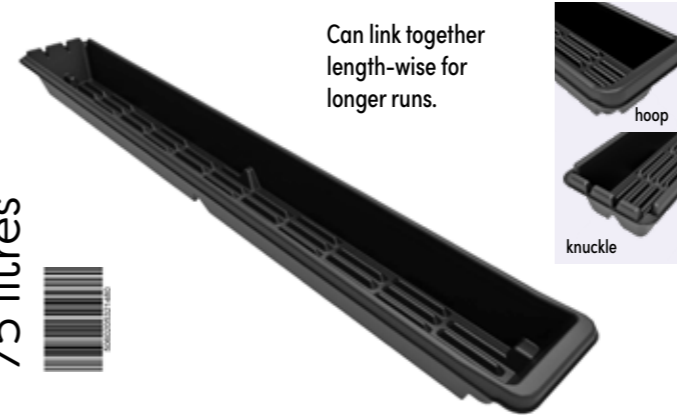

Can link together length-wise for longer runs.



FB6 hoof spreading footbath

Suitable for sheep and small livestock
Traditional style footbath commonly used with formalin
Ribbed base for safe, quick penetration of foot rot treatments
Resistant to all footrot chemicals
Easy to clean and handle, tough one piece moulding
Can link together length-wise for longer runs
Stackable with anti-jamming features
Safe large radiused corners and edges

	Dimensions mm	Capacity Litres
FB6	2500L x 340W x 190H	75



541L

Footbaths

Footbaths

541 litres



FB3 hoof spreading footbath

Specially designed floor spreads the hoof for effective footrot treatment
Suitable for large animals
Safe, large radius corners with smooth edges
Resistant to all footrot chemicals
Easy to clean and handle
Tough one piece mould

	Dimensions mm	Capacity Litres
FB3	3000L x 1100W x 240H	541



Sheep dips



www.paxtonagri.com



1250L

Sheep Dips

1250 litres



SD275RH round sheep dip

Integral Right Hand entry slide
Anti splash rim reduces spillage
Drain back exit steps
Smooth finish to reduce injury
Hard wearing MDPE
Resistant to dipping solutions

	Dimensions mm	Capacity Litres
SD275RH	2300L x 1800W x 1240H	1250



1818L

Sheep Dips



1136L

Sheep Dips

1818 litres

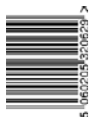

SD400LH round sheep dip

Large (1818 litre) capacity
Integral Left Hand entry slide
Drain back exit steps
Anti splash rim reduces spillage
Smooth finish to reduce injury
Hard wearing MDPE
Resistant to dipping solutions

	Dimensions mm	Capacity Litres
SD400LH	2692L x 2060W x 1283H	1818

1136 litres



SD250 rectangular sheep dip

Drain back exit steps
Anti splash rim reduces spillage
Smooth finish to reduce injury
Hard wearing MDPE
Resistant to dipping solutions

	Dimensions mm	Capacity Litres
SD250	2915L x 915W x 1220H	1136

Feed troughs



www.paxtonagri.com



28L

Feed troughs

28 litres



LF6 hanging feed troughs

Versatile hanging trough
Strong and durable one piece moulding
Smooth easy clean surface
Built in lip for hanging on bars and rails

	Dimensions mm	Capacity Litres
LF6	500L x 413W x 305H	28



73L

Feed troughs



80L

Feed troughs

73 litres

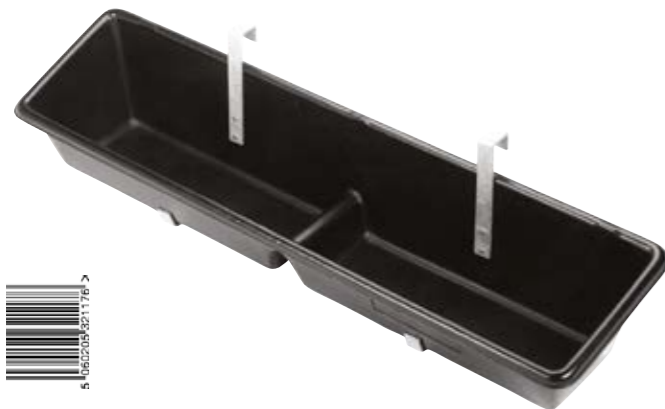

LF4 hanging feed troughs

Versatile hanging trough
Strong and durable one piece moulding
Smooth easy clean surface
Comes complete with galvanised hanging brackets and fixings

	Dimensions Dia. mm	Capacity Litres
LF4	1515L x 380W x 305H	73

80 litres



LF5 floor standing feed troughs

Larger (80 litre) capacity unit
Strong and durable, one piece, moulding
Easy to clean, safe and stable in use
Stacks when not in use

	Dimensions mm	Capacity Litres
LF5	2000L x 460W x 230H	80



LF Feed trough range



34L

Feed troughs

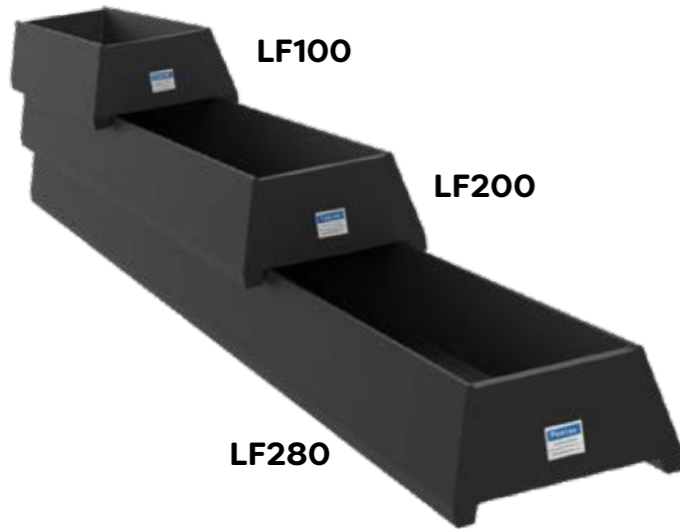

The simple design of the LF feed trough range make it hard-wearing and safe. The double skin moulding gives strength and durability. All three troughs have smooth interior and exterior surfaces, making them easy to clean. Can be stacked for storage. Plus different sizes will also inter-stack. Drainage holes can be drilled through one of the indentations on the underside of the product.

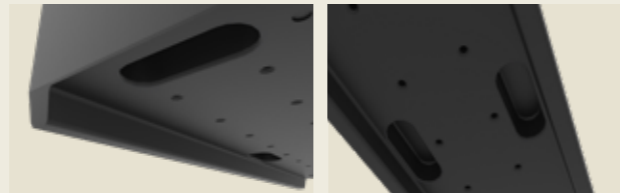

Moulded in handles on the bottom of the trough for easy lifting and moving.

34 litres



LF200 floor standing feed troughs

Double skin moulding for strength and durability
Easy clean surface with no dirt traps
Moulded in handles on the bottom of the trough
Kiss off features have been added for strength to the structure
Drainage holes can be drilled through one of the indentations on the underside of the product
Can be stacked for storage. Plus different sizes will also inter-stack

	Dimensions mm	Capacity Litres
LF200	2000L x 295W x 162H	34



16L

Feed troughs



54L

Feed troughs

16 litres



LF100 floor standing feed troughs

Double skin moulding for strength and durability
Easy clean surface with no dirt traps
Moulded in handles on the bottom of the trough
Kiss off features have been added for strength to the structure
Drainage holes can be drilled through one of the indentations on the underside of the product
Can be stacked for storage. Plus different sizes will also inter-stack

	Dimensions mm	Capacity Litres
LF100	1000L x 295W x 162H	16

54 litres



LF280 floor standing feed troughs

Double skin moulding for strength and durability
Easy clean surface with no dirt traps
Moulded in handles on the bottom of the trough
Kiss off features have been added for strength to the structure
Drainage holes can be drilled through one of the indentations on the underside of the product
Can be stacked for storage. Plus different sizes will also inter-stack

	Dimensions mm	Capacity Litres
LF280	2800L x 295W x 162H	54



18L

Feed troughs



Fits inside a 15 inch tyre (not included)
Lightweight and easy to handle
Smooth hygienic and easily cleaned
Ideal for mineral licks

	Dimensions Dia. mm	Capacity Litres
HR40A	425 x 178H	18

HR40A floor standing tyre feeder trough

Water tanks



www.paxtonagri.com

Feed troughs



www.paxtonagri.com

10000L

Water tanks

10000 litres



CT2200 JA above ground storage tank

Suitable for Potable Water (100% food grade material used throughout)
Hard wearing, one piece, stress free moulding
Manufactured from UV stabilised and frost resistant to -40 °C MDPE
Smooth hygienic surfaces
Built in lifting lugs and large screw in lid
Flat area for fitting outlets and connections
Supplied with 2" BSP Outlet. Optional Byelaw 30 kit available
WRAS approved

	Dimensions Dia. mm	Manhole Internal	Capacity Litres	Vented Insert Internal
CT2200 JA	2515 x 2575H (2540 to top of dome)	546 mm	10000	127 mm

4546L

Water tanks

4546 litres



CT1000 JA above ground storage tank

Suitable for Potable Water (100% food grade material used throughout)
Hard wearing, one piece, stress free moulding
Manufactured from UV stabilised and frost resistant to -40 °C MDPE
Smooth hygienic surfaces
Built in lifting lugs and large screw in lid
Flat area for fitting outlets and connections
Supplied with 2" BSP Outlet. Optional Byelaw 30 kit available
WRAS approved

	Dimensions Dia. mm	Manhole Internal	Capacity Litres	Vented Insert Internal
CT1000 JA	1850 x 2305H	546 mm	4546	127 mm

909L

Water tanks

909 litres



CT0200 JA above ground storage tank

Suitable for Potable Water (100% food grade material used throughout)
Hard wearing, one piece, stress free moulding
Manufactured from UV stabilised and frost resistant to -40 °C MDPE
Smooth hygienic surfaces
Built in lifting lugs and large screw in lid
Flat area for fitting outlets and connections
Supplied with 2" BSP Outlet. Optional Byelaw 30 kit available
WRAS approved

	Dimensions Dia. mm	Manhole Internal	Capacity Litres	Vented Insert Internal
CT0200 JA	1308 x 1060H	546 mm	909	127 mm

2728L

Water tanks

2728 litres



CT0600 JA above ground storage tank

Suitable for Potable Water (100% food grade material used throughout)
Hard wearing, one piece, stress free moulding
Manufactured from UV stabilised and frost resistant to -40 °C MDPE
Smooth hygienic surfaces
Built in lifting lugs and large screw in lid
Flat area for fitting outlets and connections
Supplied with 2" BSP Outlet. Optional Byelaw 30 kit available
WRAS approved

	Dimensions Dia. mm	Manhole Internal	Capacity Litres	Vented Insert Internal
CT0600 JA	1850 x 1555H	546 mm	2728	127 mm

10000L

Water tanks

10000 litres



CT2200 JB below ground storage tank

Suitable for Potable Water (100% food grade material used throughout)
Hard wearing, one piece, stress free moulding
Manufactured from UV stabilised and frost resistant to -40 °C MDPE
Smooth hygienic surfaces
Built in lifting lugs and large screw in lid
Flat area for fitting outlets and connections
WRAS approved

	Dimensions Dia. mm	Manhole Internal	Capacity Litres	Vented Insert Internal
CT2200 JB	2515 x 2575H (2548 to top of dome)	546 mm	10000	127 mm

4546L

Water tanks

4546 litres



CT1000 JB below ground storage tank

Suitable for Potable Water (100% food grade material used throughout)
Hard wearing, one piece, stress free moulding
Manufactured from UV stabilised and frost resistant to -40 °C MDPE
Smooth hygienic surfaces
Built in lifting lugs and large screw in lid
Flat area for fitting outlets and connections
WRAS approved

	Dimensions Dia. mm	Manhole Internal	Capacity Litres	Vented Insert Internal
CT1000 JB	1850 x 2305H	546 mm	4546	127 mm

909L

Water tanks

909 litres

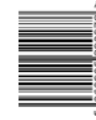

CT0200 JB below ground storage tank

Suitable for Potable Water (100% food grade material used throughout)
Hard wearing, one piece, stress free moulding
Manufactured from UV stabilised and frost resistant to -40 °C MDPE
Smooth hygienic surfaces
Built in lifting lugs and large screw in lid
Flat area for fitting outlets and connections
WRAS approved

	Dimensions Dia. mm	Manhole Internal	Capacity Litres	Vented Insert Internal
CT0200 JB	1308 x 1060H	546 mm	909	127 mm

2728L

Water tanks

2728 litres



CT0600 JB below ground storage tank

Suitable for Potable Water (100% food grade material used throughout)
Hard wearing, one piece, stress free moulding
Manufactured from UV stabilised and frost resistant to -40 °C MDPE
Smooth hygienic surfaces
Built in lifting lugs and large screw in lid
Flat area for fitting outlets and connections
WRAS approved

	Dimensions Dia. mm	Manhole Internal	Capacity Litres	Vented Insert Internal
CT0600 JB	1850 x 1555H	546 mm	2728	127 mm

250L

Water tanks



ST250V slim line tank



ST250H slim line tanks

Slim, space saving design
Fits through doorways & into narrow spaces
Large lid access for submersible pump
Tough and durable
Range of colours available

	Dimensions mm	Weight Kg	Capacity Litres
ST250V	1190L x 330W x 830H	20	250
ST250H	1190L x 830W x 330H	20	250

Dairy hygiene



www.paxtonagri.com

Rectangular wash trough being used for hay soaking



227L

Dairy hygiene

227 litres

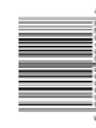

DHT2A rectangular wash trough

Rectangular Self Standing Wash Trough with lid
227 litre capacity
Double skinned for superior heat retention
Suitable for holding circulation wash water
Calibrated internal markings
One piece construction and smooth 'easy clean' surface
38mm drainage outlet complete with plug

	Dimensions mm	Capacity Litres	Drainage Outlet
DHT2A	940L x 762W x 838H	227	Yes



120L

Dairy hygiene



91L

Dairy hygiene

120 litres



DHT1A rectangular wash trough

Rectangular Self Standing Wash Trough with lid
120 litre capacity
Double skinned for superior heat retention
Suitable for holding circulation wash water
Calibrated internal markings
One piece construction and smooth 'easy clean' surface
38mm drainage outlet complete with plug

	Dimensions mm	Capacity Litres	Drainage Outlet
DHT1A	762L x 548W x 838H	120	Yes

91 litres

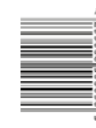

HN27A trough style wash troughs

Trough style Wash Troughs
91 litre capacity
Single skin one piece construction and smooth 'easy clean' surface
38mm drainage outlet complete with plug

	Dimensions mm	Capacity Litres	Drainage Outlet
HN27A	775L x 546W x 373H	91	Yes



132L

Dairy hygiene



45L

Dairy hygiene

132 litres



HN33A trough style wash troughs

Trough style Wash Troughs
132 litre capacity
Single skin one piece construction and smooth 'easy clean' surface
38mm drainage outlet complete with plug

	Dimensions mm	Capacity Litres	Drainage Outlet
HN33A	950L x 550W x 388H	132	Yes

45 litres



CH50 churn

Strong, lightweight design
45 litre capacity
Screw cap lid
Steel grab handles

	Dimensions Dia. mm	Capacity Litres	Drainage Outlet
CH50	335 x 735H	45	NA



209L

Dairy hygiene

209 litres



HN36A trough style wash troughs

Trough style Wash Troughs
209 litre capacity
Single skin one piece construction and smooth 'easy clean' surface
38mm drainage outlet complete with plug

	Dimensions mm	Capacity Litres	Drainage Outlet
HN36A	970L x 685W x 482H	209	Yes

Other information

Installation & User Guides

Copies of the following Installation and User Guides can be found on www.paxtonagri.com

- Sheep Dip Recommended Site Instructions
- WT 75 & 120 Drinking Troughs
- Perfo Ground Stabilisation Matting
- Below Ground CT Water Tanks
- Above Ground CT Water Tanks

Conversion Guide

To convert litres to gallons multiply by 0.219
To convert millimetres to inches multiply by 0.0394

Colours

As a special order, it is sometimes possible to produce other products in a colour shown in the chart. Please contact our customer services department to discuss.

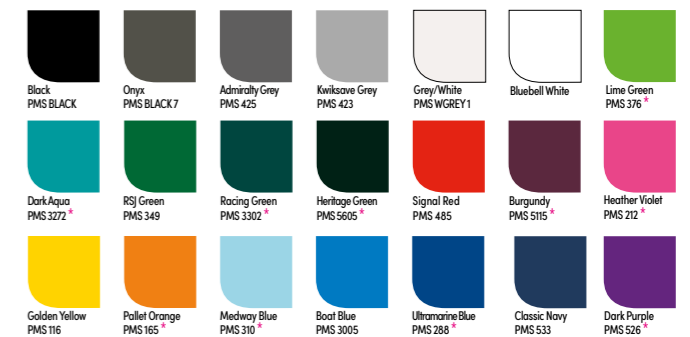

* Denotes a colour with a longer lead time
** Denotes a colour with a premium price point

Premium Colours

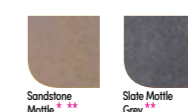

Recycled Options



Please call to discuss our recycled option...

Paxton

A division of Leaffield Environmental Ltd



Leaffield Way,
Leaffield Industrial Estate,
Corsham, Wilts, SN13 9UD

Tel: 01225 816528

Fax: 01225 816501

Email: Paxton@leaffieldenv.com

www.paxtonagri.com



Paxtonagri



Paxton_agri



Paxtonagri



PaxtonAgriLtd

Distributed by:

www.paxtonagri.com

